



# Ultrafiltration

## Product Manual

VERSION 3

APRIL 2011

THIS MANUAL IS CONFIDENTIAL. IT IS THE PROPERTY OF DOW WATER & PROCESS SOLUTIONS. THE CONTENTS MAY NOT BE REPRODUCED, TRANSFERRED OR RELEASED TO ANY THIRD PARTY WITHOUT THE WRITTEN PERMISSION OF DOW WATER & PROCESS SOLUTIONS.

# TABLE OF CONTENTS

Version 3.....	ii
April 2011.....	ii
Table of Contents.....	iii
DOW™ ULTRAFILTRATION PRODUCT MANUAL.....	1
1. Introduction.....	1
2. Description of DOW™ Ultrafiltration Module.....	2
2.1 Module Features.....	2
2.2 Module Specifications.....	4
2.3 Module Installation.....	7
3. Shipping and Storage.....	9
4. DOW Ultrafiltration Process Description.....	11
4.1 Process Operations.....	11
4.2 Pretreatment.....	17
4.3 Cleaning.....	18
Summary of Information.....	18
4.4 Fouling.....	18
5. Operating Information.....	18
5.1 Start Up.....	18
Pre-start checks.....	19
Start Up.....	19
Module flushing.....	19
5.2 Integrity Testing procedures.....	19
Bubble Test.....	19
Pressure hold/decay.....	20
5.3 Shut Down.....	20
Manual shut down.....	20
Equipment shut down during automatic operation.....	20
Long term equipment shut down.....	20
5.4 Operating and Cleaning Logs.....	21

## References

Figure 1: Material Size and Membrane Process Guide .....	1
Figure 2: Wall Cross Section of the Hollow Fiber .....	2
Figure 3: Photograph of a 28XX Module and a 2660 Module .....	3
Figure 4: SFP 2860 and 2880 Module Reference for Dimensions.....	5
Figure 5: SFP 2660 Module Reference for Dimensions .....	6
Figure 6: Cross Section of SFP 2660 Module .....	6
Figure 7: Installation Drawing of 2860 and 2880 Module.....	7
Figure 8: Installation Drawing of 2660 Module .....	8
Figure 9: DOW™ UF Installation using 2860 Modules .....	9
Figure 10: Pallets of Modules for Shipping .....	9
Figure 11: Filtration Step for DOW UF Modules .....	12
Figure 12: Air Scour Step for DOW UF Modules .....	13
Figure 13: Module Gravity Drain Step After Air Scour for DOW UF Modules.....	13
Figure 14: Top Backwash Step for DOW UF Modules .....	14
Figure 15: Bottom Backwash Step for DOW UF Modules .....	14
Figure 16: Forward Flush Step for DOW UF Modules.....	15
Figure 17: Chemically Enhanced Backwash “Top” Step for DOW UF Modules .....	15
Figure 18: Chemically Enhanced Backwash “Bottom” step for DOW UF Modules .....	16
Figure 19: Clean In Place Cleaning Step for DOW UF Modules.....	17
Figure 20: Pressure Hold Test Schematic .....	20

## Tables

Table 1: Size and Type of Module Connections .....	3
Table 2: Module Specifications .....	4
Table 3: Skid shut down summary.....	10
Table 4: Glycerin vs. Freezing Point Depression .....	11
Table 5: DOW Ultrafiltration Operating Conditions .....	12
Table 6: Qualified Feed Water Quality Parameters .....	17
Table 7: Summary of Cleaning Processes.....	18

# DOW™ ULTRAFILTRATION PRODUCT MANUAL

## 1. INTRODUCTION

Ultrafiltration (UF) involves pressure-driven separation of materials from a feed solution. The technology is used to remove particulate and microbial contaminants, but it does not remove ions and small molecules. Pressure drives the process, which typically operates with a feed pressure of 4 to 100 psig. UF plants are automated and have low operational labor requirements. These systems, however, can require frequent cleaning. UF membranes have a service life of three to five years or longer, which is comparable to reverse osmosis membranes. UF modules are commercially available in tubular, hollow-fiber, plate and frame, and spiral wound configurations.

UF membranes reject solutes ranging in size from 0.03 microns and larger. Figure 1 provides a guide to the relationship between common materials, separation processes, and pore size measurements. The UF membrane process separates molecules in solution on the basis of size. The pore size and molecular weight cut-off (MWCO) are often used to characterize a membrane. The pore size is the nominal diameter of the openings or micropores in the membrane expressed in microns. The MWCO is the molecular mass or weight of a solute that rejects greater than 90 percent. The unit of measurement for MWCO is the Dalton (D).

Different membrane materials with the same nominal MWCO may have differing solute rejection. Pore size distribution and uniformity rather than the chemical nature of the membrane material may cause this effect. Because factors other than pore size or MWCO affect the performance of membranes, challenge studies are used to demonstrate membrane performance and benchmark different membranes.

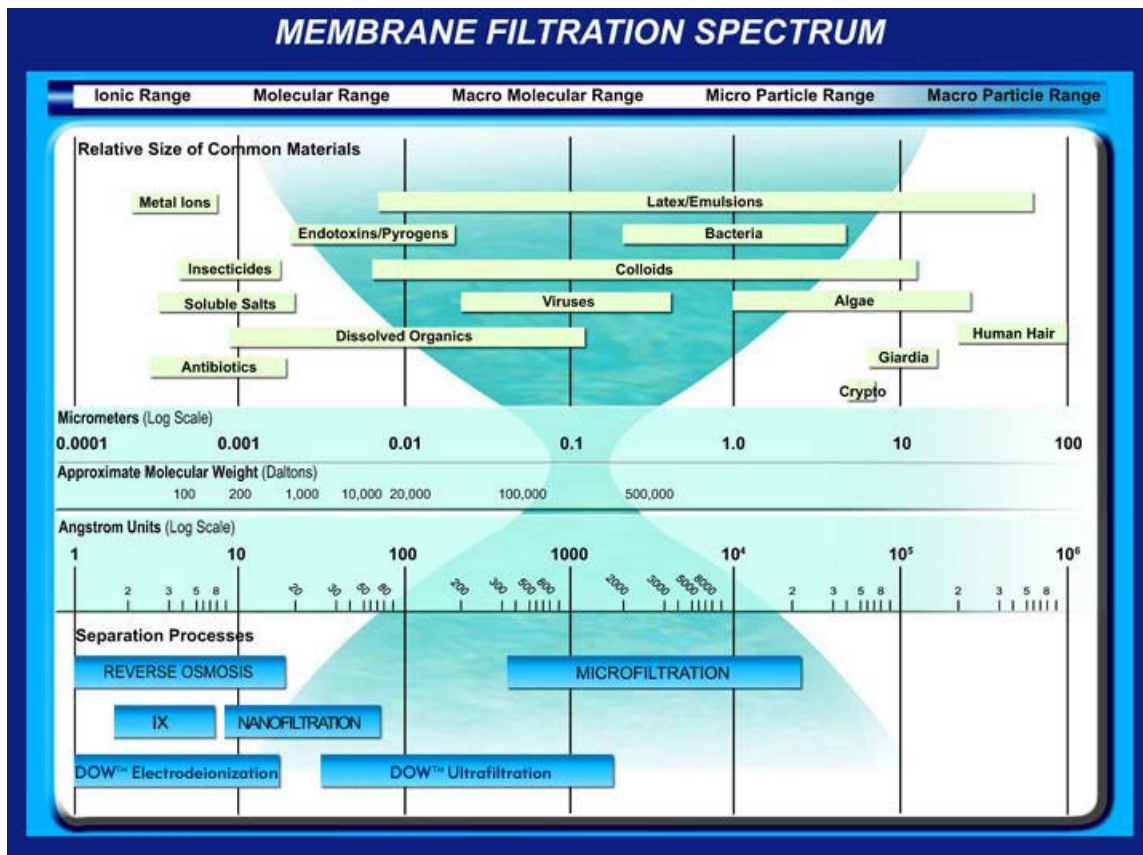

Figure 1: Material Size and Membrane Process Guide

## 2. DESCRIPTION OF DOW™ ULTRAFILTRATION MODULE

### 2.1 MODULE FEATURES

The DOW Ultrafiltration modules are made from high strength, hollow fiber membranes that offer the following features:

- 0.03  $\mu\text{m}$  nominal pore diameter for removal of bacteria, viruses, and particulates including colloids
- PVDF polymeric hollow fibers for high strength and chemical resistance
- Hydrophilic PVDF fibers for easy cleaning and wettability that help maintain long term performance
- Outside-In flow configuration for high tolerance to feed solids and the use of air scour cleaning
- U-PVC housings eliminate the need for pressure vessels and are resistant to UV light

The outside-In flow configuration is tolerant of wide ranging feed water qualities and allows air scour cleaning. The dead-end flow offers higher recovery and energy savings. The pressurized vertical shell-and-tube design eliminates the need for separate pressure vessels and allows easy removal of air from cleaning and integrity testing steps.

The hollow fiber membranes are 1.3 mm outside diameter and 0.7 mm inside diameter and are made from PVDF polymer. The fibers are strong because of a combination of the PVDF polymer, asymmetric dense spongy layer, and skins formed on each side of the fiber. The PVDF membranes offer high chemical resistance and are tolerant to temperatures of 40°C. The hydrophilicity of the PVDF fibers is increased by using a proprietary treatment during manufacturing.

The 0.03 $\mu\text{m}$  nominal pore size combines high filtration performance and high flux. The smaller pore size provides stable long term filtration performance compared to microfiltration.

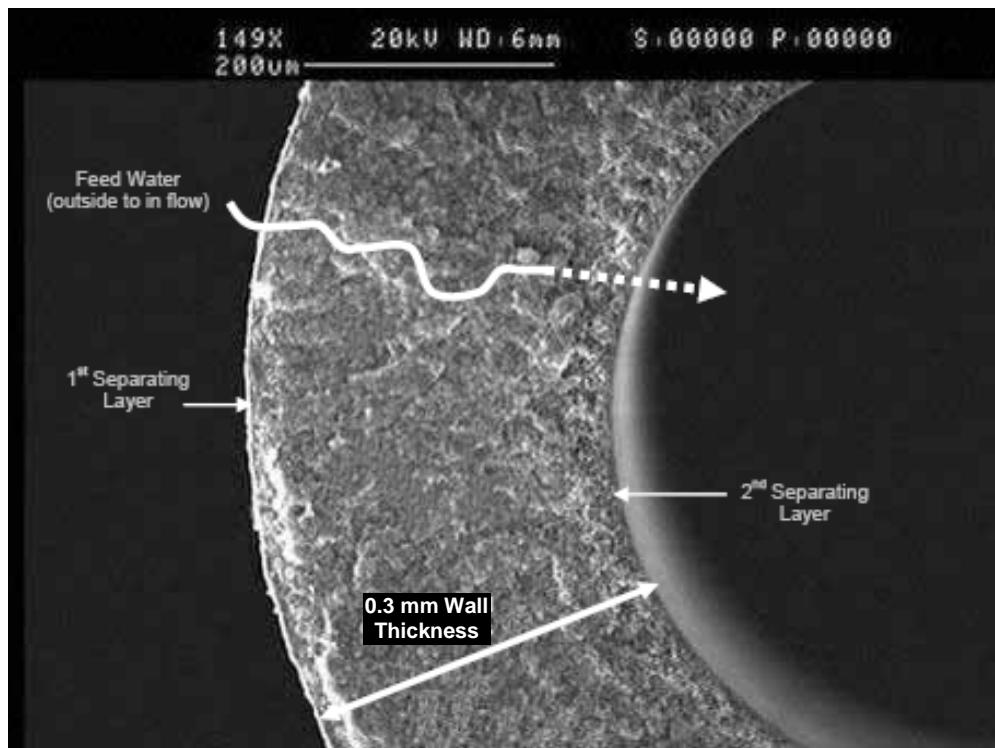

Figure 2: Wall Cross Section of the Hollow Fiber

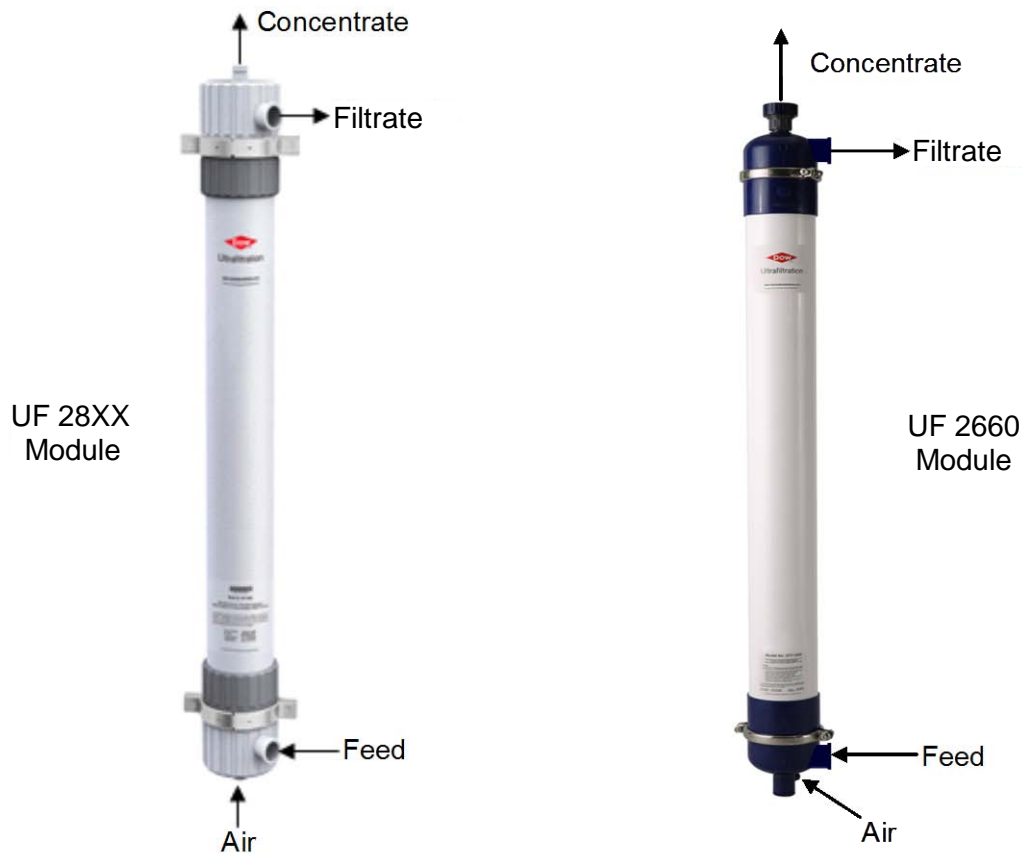

Figure 3: Photograph of a 28XX Series Module and a 2660 Module

There are four connections on each module. The flow enters the module through the side port located on the bottom end cap. Feed begins on the outside of the fiber. The air feed is located on the bottom of the end cap and is used for air scouring on the outside of the fiber during cleaning. The concentrate (discharges flow from the outside of fiber) and filtrate ports (inside of fiber) are located on the top cap. Table 1 below shows the type and size of the connections for each module.

Table 1: Size and Type of Module Connections

Module	Feed and Product	Concentrate	Air	Base	Skid
SFP 2660	DN 50 Victaulic	DN 32 Threaded	3/8 inch Threaded	Nipple Plastic	Saddle and Strap
SFP 2860/2880	DN 50 Victaulic	DN 50 Victaulic	3/8 inch Threaded	Circular Clip Plastic	Saddle and Strap

## 2.2 MODULE SPECIFICATIONS

The specifications for each module are shown in Table 2 below and as depicted in Figures 4 through 6.

Table 2: Module Specifications

Module Properties	SFX-2660		SFX-2860		SFX-2880	
	SI	US	SI	US	SI	US
Length - L	1860 mm	73.2"	1860 mm	73.2"	2360 mm	92.9"
Length - L1	1500 mm	59.1"	1500 mm	59.1"	2000 mm	78.7"
Length - L2	1610 mm	63.4"	1630 mm	64.2"	2130 mm	83.9"
Length - L3	1710 mm	67.3"	1820 mm	71.7"	2320 mm	91.3"
Diameter - D	165 mm	6.5"	225 mm	8.9"	225 mm	8.9"
Width – W1	125 mm	4.9"	180 mm	7.1"	180 mm	7.1"
Width – W2	250 mm	9.8"	342 mm	13.5"	342 mm	13.5"
Surface Area	33 m <sup>2</sup>	355 ft <sup>2</sup>	51 m <sup>2</sup>	549 ft <sup>2</sup>	77 m <sup>2</sup>	829 ft <sup>2</sup>
Volume per Module	16 L	4.2 gal	35 L	9.3 gal	39 L	10.3 gal
Weight (water filled)	41 kg	90 lbs	83 kg	183 lbs	100 kg	220 lbs
Shipping Weight (w/o packaging)	25 kg	55 lbs	48 kg	106 lbs	61 kg	135 lbs
Fibers/ Module	5,760		9,000		10,000	
Housing	UPVC		UPVC		UPVC	



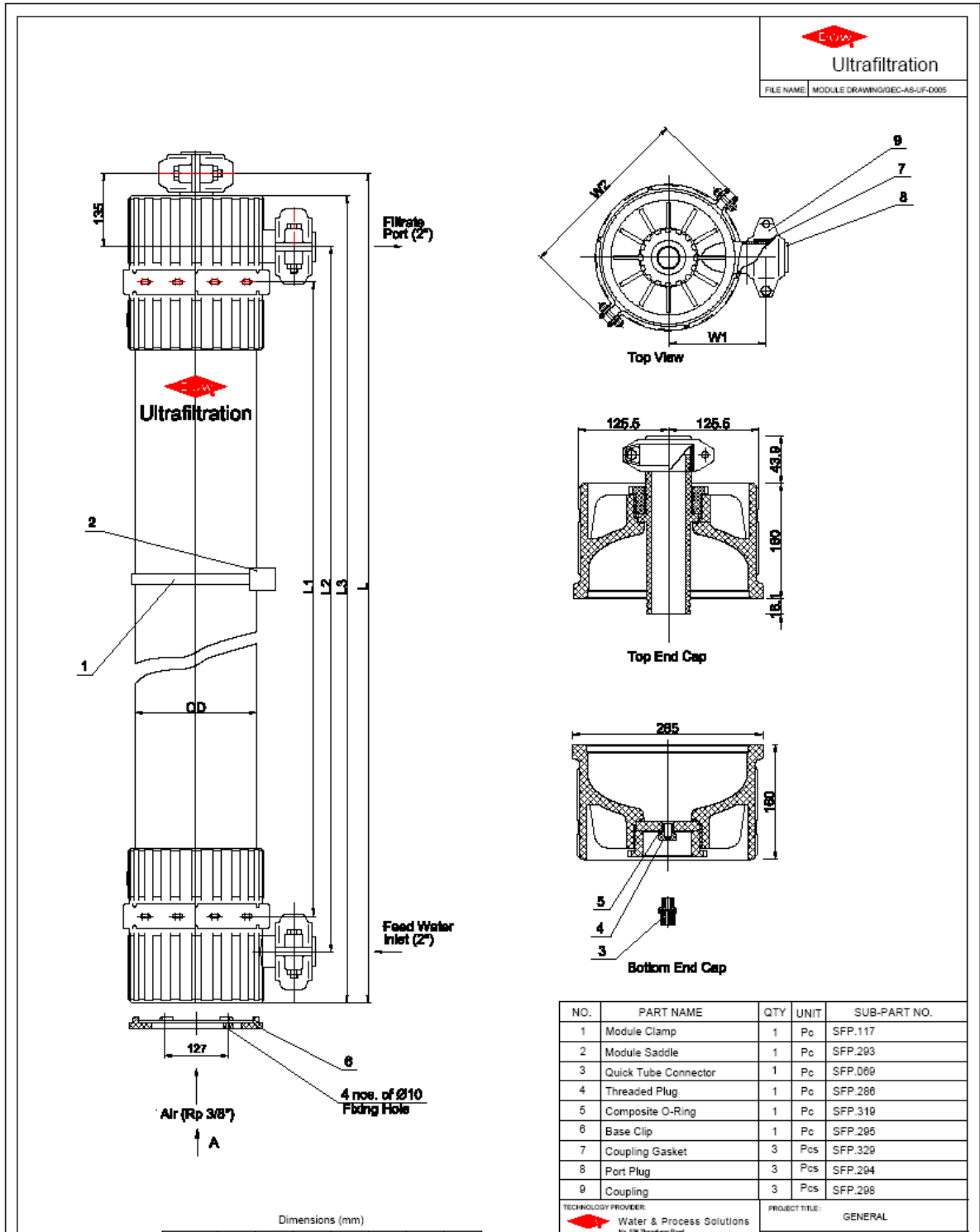

Figure 4: SFP 2860 and 2880 Module Reference for Dimensions

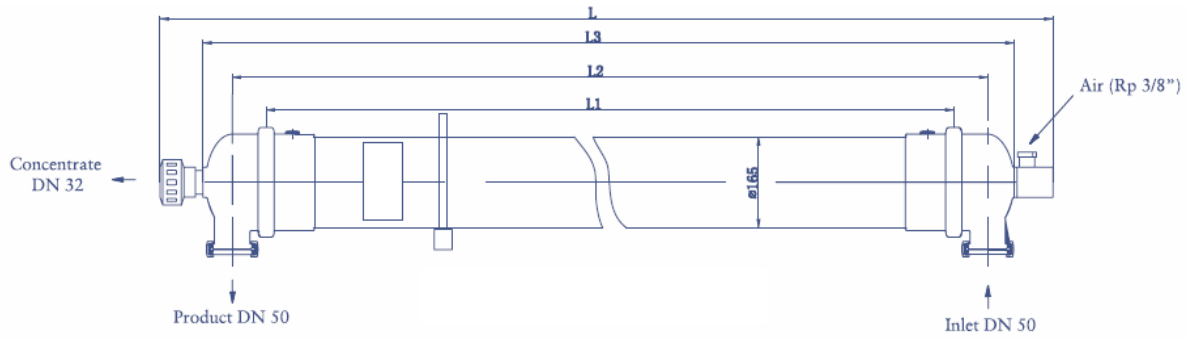

Figure 5: SFP 2660 Module Reference for Dimensions

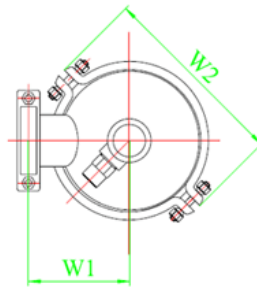

Figure 6: Cross Section of SFP 2660 Module

## 2.3 MODULE INSTALLATION

Figures 7 and 8 provide the installation details for DOW™ UF modules. A skid installation is shown in figure 9.

**Ultrafiltration**  
PART NAME: DOW™ Ultrafiltration Module

**Fig. 2, Base Clip Detail**

**Fig. 3, Saddle and Clamp Detail**

**Fig. 4, Grooved Connector Detail**

**Fig. 5, View of Bottom End Cap**

**Installation Instructions:**

1. Install Base Clip (1). Drill two 10 mm diameter holes on Skid Frame. Fit Base Clip on Skid Frame (2) (By Customer) with Bolt (3) (M6-size, by Customer). The length of the Bolt (3) will depend on the thickness of the Skid Frame. Refer to Figure 2, Base Clip Detail.
2. Install Saddle (4) to Skid Frame (2). Drill two 7 mm diameter holes on Skid Frame. Position Saddle nipple into two 7 mm diameter holes on Skid Frame. Tap Saddle with rubber mallet to mount the nipple into the holes. Refer to Figure 3, Saddle and Clamp Detail.
3. Partial Install of Module Clamp (5). Drill two 10 mm diameter holes on Skid Frame. Fit one side of clamp with Bolt (8) (M6-Size, 90 mm length, by Dow). Refer to Figure 3, Saddle and Clamp Detail.
4. Drain Preservative. At Openings 1, 2, and 3, remove Port Plug (7). Place UF Module in vertical position to drain out preservative. Appropriate Environmental, Health, and Safety measures should be taken for handling and disposal of the preservative. Port Plug may be retained for future use.
5. Mount UF Module (8) to Base Clip (1). Chain block or hoist is recommended for handling and positioning of UF module. Base of UF Module will snap into Base Clip.
6. Place Head Cover (8) on the top of UF Module (8). The use of Head Cover is optional, and for aesthetic purposes.
7. At Openings 1, 2, and 3, use Coupling (10) and Coupling Gasket (11) to connect UF Module port with Grooved Connector (12) (DN50, by Customer). The bolts for Couplings should be tightened to torque of 5 to 10 N·m. The length of Grooved Connector will depend on pipework design of the Skid Frame. Refer to Figure 4, Grooved Connector Detail.
8. At Opening 4, remove Threaded Plug (13), and fit Quick Tube Connector (14) with Composite O-Ring (15) at the bottom of UF Module. Refer to Figure 4, Bottom End Cap Detail. Threaded Plug may be retained for future use.

**Notes:**

1. UF Module should be kept preserved, as shipped from factory, until ready for operation. If leakage occurs, refer to DOW™ Ultrafiltration Technical Manual for procedure to replace preservative.
2. Upstream process pipework should be thoroughly flushed prior to installation and commissioning.
3. Preservative consists primarily of Sodium Metasilicate (about 1% solution).

PACKING LIST			
NO.	PART NAME	QTY.	UNIT
1	DOW™ Ultrafiltration Module	1	Pc
2	Quick Tube Connector	1	Pc
3	Module Saddle	1	Pc
4	Module Clamp	1	Pa
5	Head Cover	1	Pa
6	Base Clip	1	Pa
7	Module Clamp Bolt	2	Pca

ADDITIONAL MATERIAL LIST (not supplied with modules)			
NO.	NAME	QTY.	UNIT
1	Grooved Connector	3	Pca
2	Bolt	4	Pca
3	Nut	4	Pca

TECHNOLOGY PROVIDER: Water & Process Solutions

PROJECT TITLE: GENERAL

Figure 7: Installation Drawing of 2860 and 2880 Module



**Ultrafiltration**

FILE NAME: INSTALLATION DRAWING-AS-UP-001

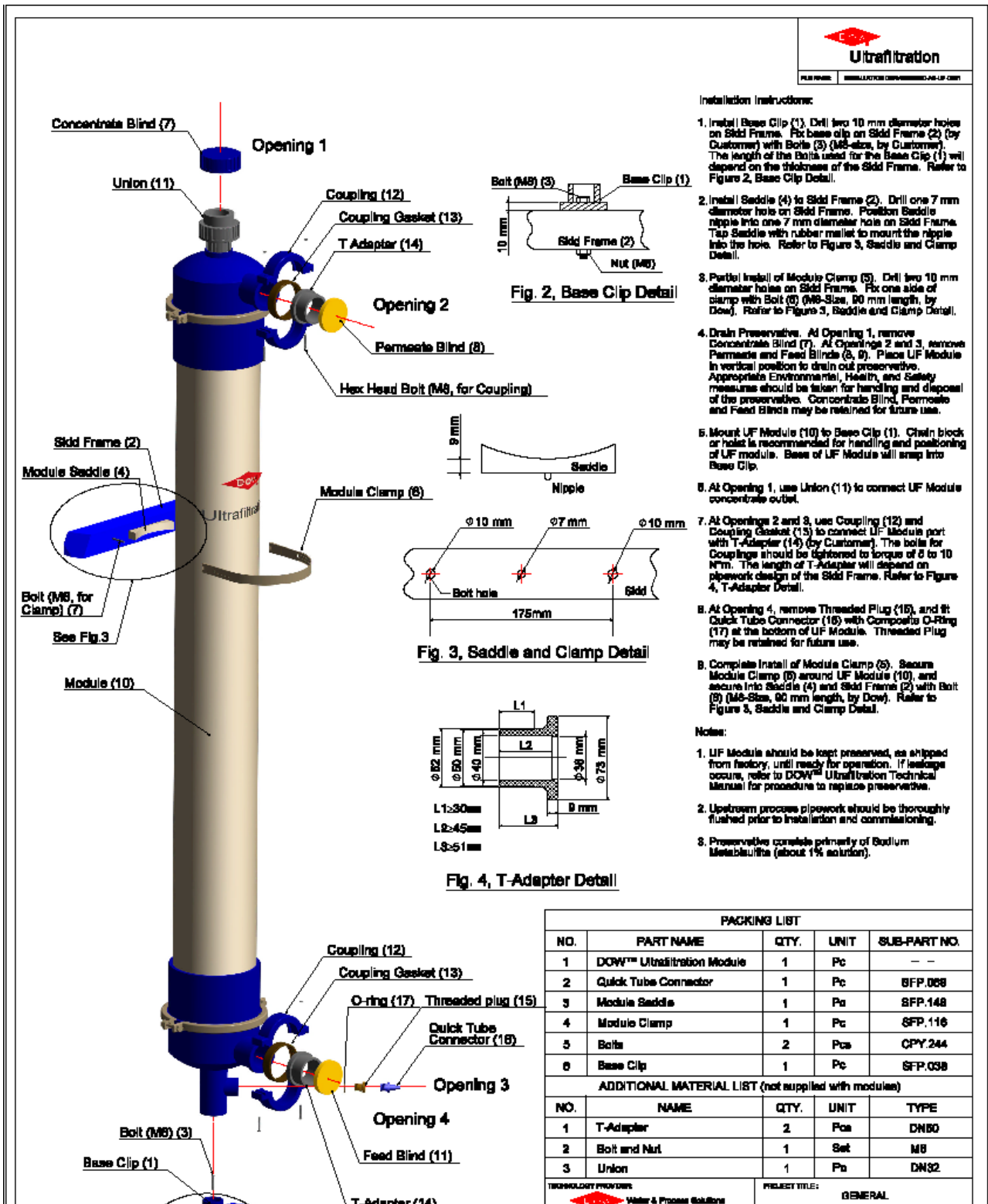

**Installation Instructions:**

1. Install Base Clip (1). Drill two 10 mm diameter holes on Skid Frame. Fix base clip on Skid Frame (2) (by Customer) with Bolts (3) (M8-size, by Customer). The length of the Bolts used for the Base Clip (1) will depend on the thickness of the Skid Frame. Refer to Figure 2, Base Clip Detail.
2. Install Saddle (4) to Skid Frame (2). Drill one 7 mm diameter hole on Skid Frame. Position Saddle nipple into one 7 mm diameter hole on Skid Frame. Tap Saddle with rubber mallet to mount the nipple into the hole. Refer to Figure 3, Saddle and Clamp Detail.
3. Partial Install of Module Clamp (5). Drill two 10 mm diameter holes on Skid Frame. Fix one side of clamp with Bolt (6) (M8-Size, 80 mm length, by Dow). Refer to Figure 3, Saddle and Clamp Detail.
4. Drain Preservative. At Opening 1, remove Concentrate Blind (7). At Opening 2 and 3, remove Permeate and Feed Blinds (8, 9). Place UF Module in vertical position to drain out preservative. Appropriate Environmental, Health, and Safety measures should be taken for handling and disposal of the preservative. Concentrate Blind, Permeate and Feed Blinds may be retained for future use.
5. Mount UF Module (10) to Base Clip (1). Chain block or hoist is recommended for handling and positioning of UF module. Base of UF Module will snap into Base Clip.
6. At Opening 1, use Union (11) to connect UF Module concentrate outlet.
7. At Opening 2 and 3, use Coupling (12) and Coupling Gasket (13) to connect UF Module port with T-Adapter (14) (by Customer). The bolts for Couplings should be tightened to torque of 8 to 10 N\*m. The length of T-Adapter will depend on pipework design of the Skid Frame. Refer to Figure 4, T-Adapter Detail.
8. At Opening 4, remove Threaded Plug (15), and fit Quick Tube Connector (16) with Composite O-Ring (17) at the bottom of UF Module. Threaded Plug may be retained for future use.
9. Complete Install of Module Clamp (5). Secure Module Clamp (5) around UF Module (10), and secure into Saddle (4) and Skid Frame (2) with Bolt (6) (M8-Size, 80 mm length, by Dow). Refer to Figure 3, Saddle and Clamp Detail.

**Note:**

1. UF Module should be kept preserved, as shipped from factory, until ready for operation. If leakage occurs, refer to DOW™ Ultrafiltration Technical Manual for procedure to replace preservative.
2. Upstream process pipework should be thoroughly flushed prior to installation and commissioning.
3. Preservative consists primarily of Sodium Metasilicate (about 1% solution).

PACKING LIST				
NO.	PART NAME	QTY.	UNIT	SUB-PART NO.
1	DOW™ Ultrafiltration Module	1	Pc	--
2	Quick Tube Connector	1	Pc	SFP.068
3	Module Saddle	1	Pc	SFP.148
4	Module Clamp	1	Pc	SFP.116
5	Bolts	2	Pcs	CPY.244
6	Base Clip	1	Pc	SFP.038
ADDITIONAL MATERIAL LIST (not supplied with modules)				
NO.	NAME	QTY.	UNIT	TYPE
1	T-Adapter	2	Pcs	DN80
2	Bolt and Nut	1	Set	M8
3	Union	1	Pc	DN32
TECHNOLOGY PROVIDER:  Water & Process Solutions			PROJECT TITLE: GENERAL	

Figure 8: Installation Drawing of 2660 Module



Figure 9: DOW UF Installation using 2860 Modules

### 3. SHIPPING AND STORAGE

To control bacterial growth and prevent damage caused by drying out, the DOW™ Ultrafiltration modules are wetted and stored in pH buffered 1% sodium metabisulphite solution. Preservative is automatically injection into the modules, then all inlet and outlet ports are sealed using plastic discs, Victaulic flanges, and plugs. If the modules are exposed to low temperatures, glycerin can be added to the preservative to prevent freezing. The modules are sealed in plastic prior to boxing. Depending on the total number of modules and method of shipping, the modules are either shipped on pallets as shown in Figure 10 below or in crates.



Figure 10: Pallets of Modules for Shipping



### Uninstalled modules:

The modules should be stored horizontally with the connections/ports facing up. To prevent collapse of the packaged modules, stacking should be limited to four layers for the 2660 and 2860 modules and to three layers for the 2880 modules. Storage in a cool, dry, normally ventilated area protected from direct sunlight with an ambient temperature of 20 to 35°C is recommended. Sealed modules can be stored up to 1 year at the recommended conditions in the original packing. For a 2660 module 2 liters of preservative are added. For a 2860 module 4 liters of preservative are added. For a 2880 module 6 liters of preservative are added. The UF module shelf life is one year from the manufacture date with out taking additional measures for preservation as long as the storage condition instructions are followed.

### Storage of modules installed on a skid:

Modules installed during assembly of a skid should not be allowed to dry out. Dry membrane fibers will irreversibly lose flux. Blank or "dummy" modules are available through the manufacturer to accurately build and assemble a skid. Consult the manufacturer regarding modules installed on a skid and not planned for operations within 7 days.

If the modules are installed to wet test the system before shipping and it is desired to ship the modules installed on the skid the following steps should be taken: add sodium bisulfite preservative, drain the system to remove excess preservative and weight, and reseal the system by closing all valves. Once the system arrives on site the modules should be refilled with preservative prior to start up.

UF systems are designed to run continuously and membrane systems perform better when operated continuously. However, in reality UF systems will start-up and shutdown on some frequency. When the UF system is shutdown, the system must be cleaned using air-scour and backwashed with filtrate water to prevent bacterial growth in the UF system.

The water used for backwash before shutdown should not contain chemicals. Any feed water and backwash chemical dosing used should be stopped before the last cleaning and shutdown. After cleaning, all valves on the UF system should be closed to seal the system.

To avoid leakage in the module housing end caps and clamps, the backpressure in the modules should be controlled when the UF system shuts down, especially in case of non-scheduled shutdowns, e.g. power failure or emergency shutdowns.

When the system is down for greater than 48 hours, note the following:

- The module should not dry out. Dry membrane fibers will irreversibly lose flux at any time.
- The system should be adequately protected against micro-biological growth, flushed 30 to 60 minutes per day, or operated every 24 hours.
- The system should be protected against temperature extremes. The UF system can be shut down for 48 hours without adding preservative and taking precautions for microbiological fouling.

When the system is down for greater than 48 hours, note the following:

- Addition of chemical preservative is necessary for system down time greater than 48 hours.

Table 3: Skid shut down summary

Storage duration	Recommended Steps
0 to 48 hours	Air scour and backwash, close all valves
>2 days to 7 days	Air scour and backwash, close all valves, perform 30 to 60 minutes of operations daily or air scour, backwash, add preservative then close all valves
>7 days to 90 days	Add preservative and renew preservative every three months
>90 days	Consult the manufacturer

### Storage of modules off skid:

If the UF system will be out of service for a long time the modules can be removed from the skid and stored to avoid routine operations as defined above. Air scour and backwash should be applied before decommissioning the equipment. Add 2, 4, and 6 liters of 1% sodium bisulfite preservative into the filtrate port of a 2660 and 2880 module respectively. Once the preservative is added into the module, all inlet and outlet ports should be sealed using the plastic discs, Victaulic flanges, and plugs as shipped from the factory. Modules should be placed in a plastic bag to protect the module. Each module should be placed horizontal with the feed ports facing up into an individual or separate shipping box or crate. If the modules are exposed to freezing conditions glycerin should be added to the preservative to achieve a 20% concentration. Table 4 below is provided for reference. Modules prepared as described can be stored for 90 days. Consult the manufacturer for storage durations greater than 90 days.

### Warranty return of modules:

Review the project warranty information for authorization instructions before shipping modules for return. To prepare a module for shipment drain the module, plug or seal the openings/ports, and secure the module on a pallet or in a crate.

Table 4: Glycerin vs. Freezing Point Depression

Glycerin Wt %	Viscosity cP	Freezing Point Depression °C
0.5	1.011	0.07
3.0	1.074	0.63
5.0	1.127	1.08
9.0	1.256	2.06
12.0	1.365	2.88
14.0	1.445	3.47
16.0	1.533	4.09
20.0	1.737	5.46
24.0	1.988	7.01
28.0	2.279	8.77
32.0	2.637	10.74
36.0	3.088	12.96
40.0	3.653	15.50
44.0	4.443	17.73
48.0	5.413	20.39
52.0	6.666	23.22
56.0	8.349	26.23
60.0	10.681	29.41

## 4. DOW ULTRAFILTRATION PROCESS DESCRIPTION

### 4.1 PROCESS OPERATIONS

The basic operating conditions for the DOW Ultrafiltration modules are shown in Table 5 below. The process operating parameters for the cleaning steps in provided in the cleaning section.

Table 5: DOW Ultrafiltration Operating Conditions

Operating Conditions	SI	US
Feed Pressure, Maximum at Inlet at 20 °C	6.25 Bar	93.75 psi
Operating TMP (Maximum)	2.1 Bar	30 psi
Filtrate Flux @25C	40 - 120 L/m <sup>2</sup> /hr	24 - 70 gfd
Temperature (UPVC limited )	1 – 40 °C	34 - 104 °F
Operating pH Range	2 - 11	
NaOCl, Cleaning Maximum	2,000 ppm	

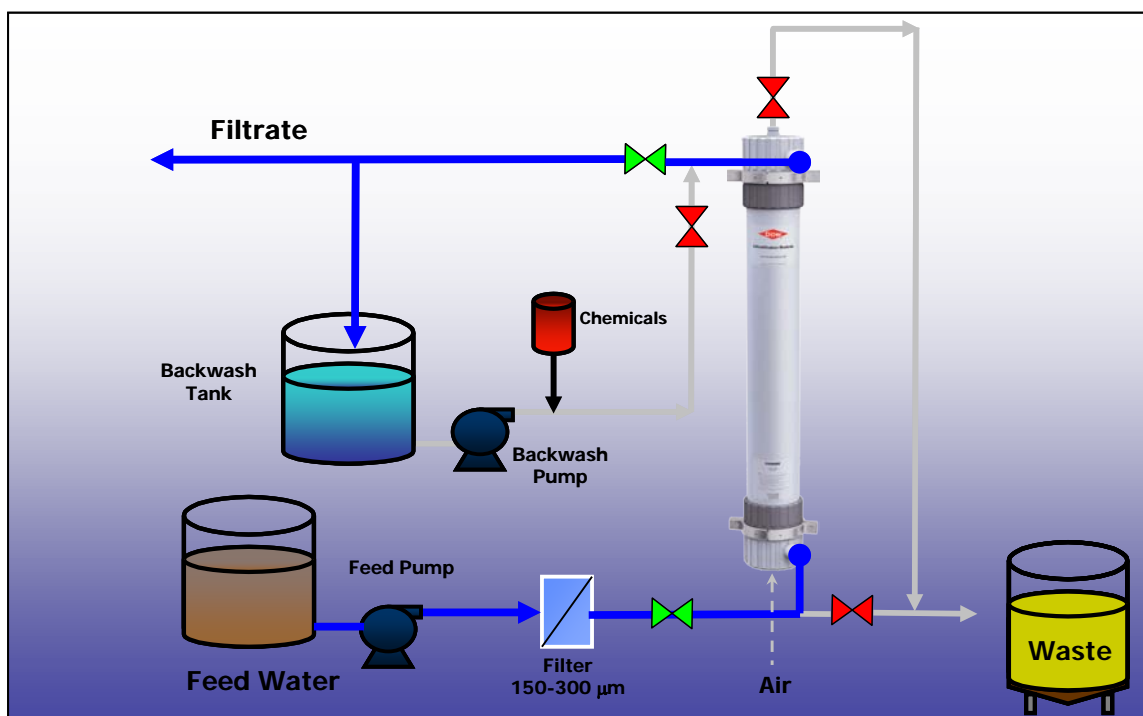

Figure 11: Filtration Step for DOW UF Modules

**Normal operation** refers to the routine operating sequence of a system using the DOW™ Ultrafiltration module and includes the operating and backwash steps. At initial start up the modules are flushed using a **“forward flush”** to remove any residual chemicals or trapped air from the module. The flush occurs on the outside of the fibers and does not filter the feed water to make filtrate. After the **forward flush** is discontinued the modules can be placed in the **operating mode**. An operating cycle ranges from 20 to 60 minutes. While operating 100% of the feed water is converted to filtrate. As contaminants are removed during the operating step the transmembrane pressure will rise. At the end of the preset operating cycle time, a backwash sequence is triggered.



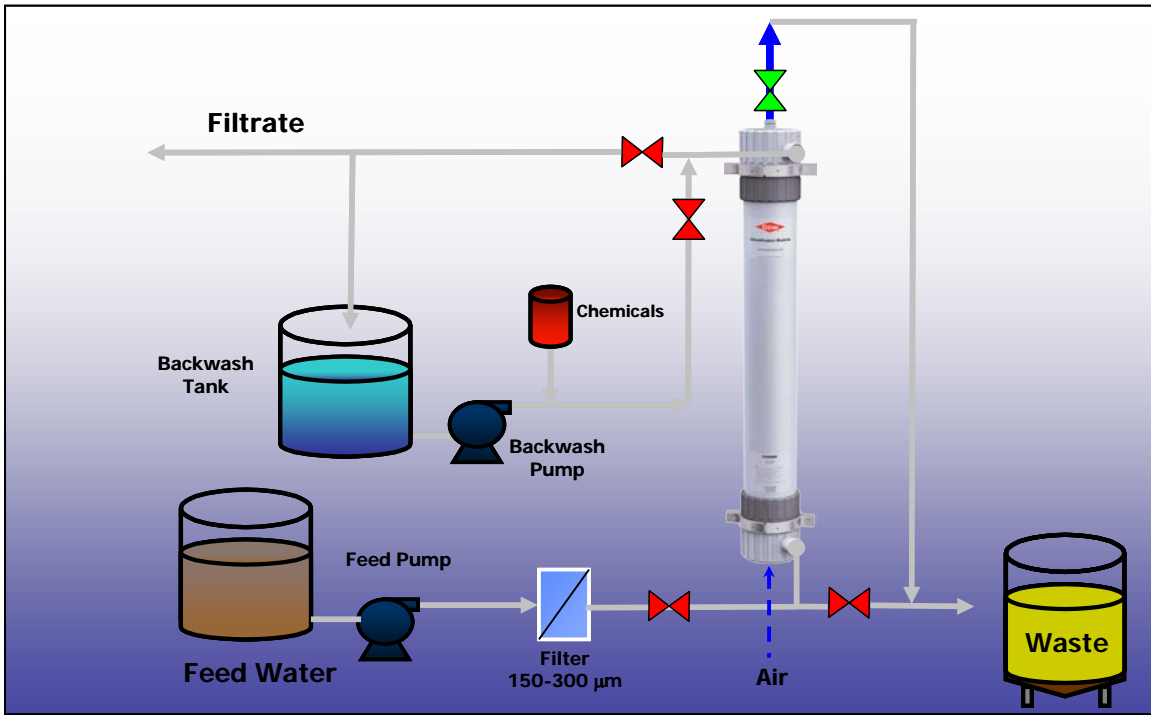

Figure 12: Air Scour Step for DOW UF Modules

The *backwash mode* occurs automatically and may include an air scour, but always includes draining, backwash through the top drain, backwash through the bottom drain, and a forward flush. The *air scour* step, when included, is used to loosen particulates deposited on the outside of the membrane surface. Air is introduced on the outside of the fibers and displaced feed flow/concentrate is allowed to discharge through the top of the module for disposal. After 20 to 30 seconds of air scour the module is *drained* by gravity to remove dislodged particulates. If the air flush is not included, the backwash sequence is started with simply draining the module by gravity to remove the concentrated feed water before starting any backwashing.

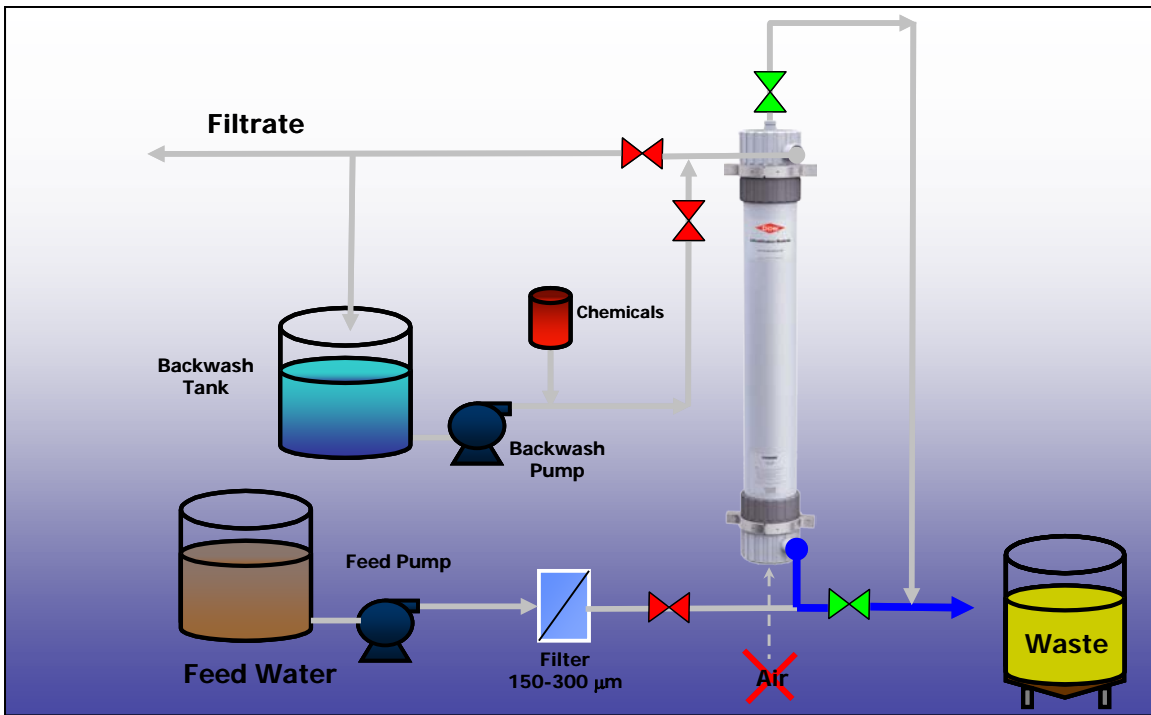

Figure 13: Module Gravity Drain Step After Air Scour for DOW UF Modules

After draining the *first backwash* step is performed. Filtrate flow is reversed from the inside of the fiber to the outside and backwash flow is removed from the module housing through the top drain on the module. A top draining backwash is performed first to remove contaminants in the area of greatest concentration.

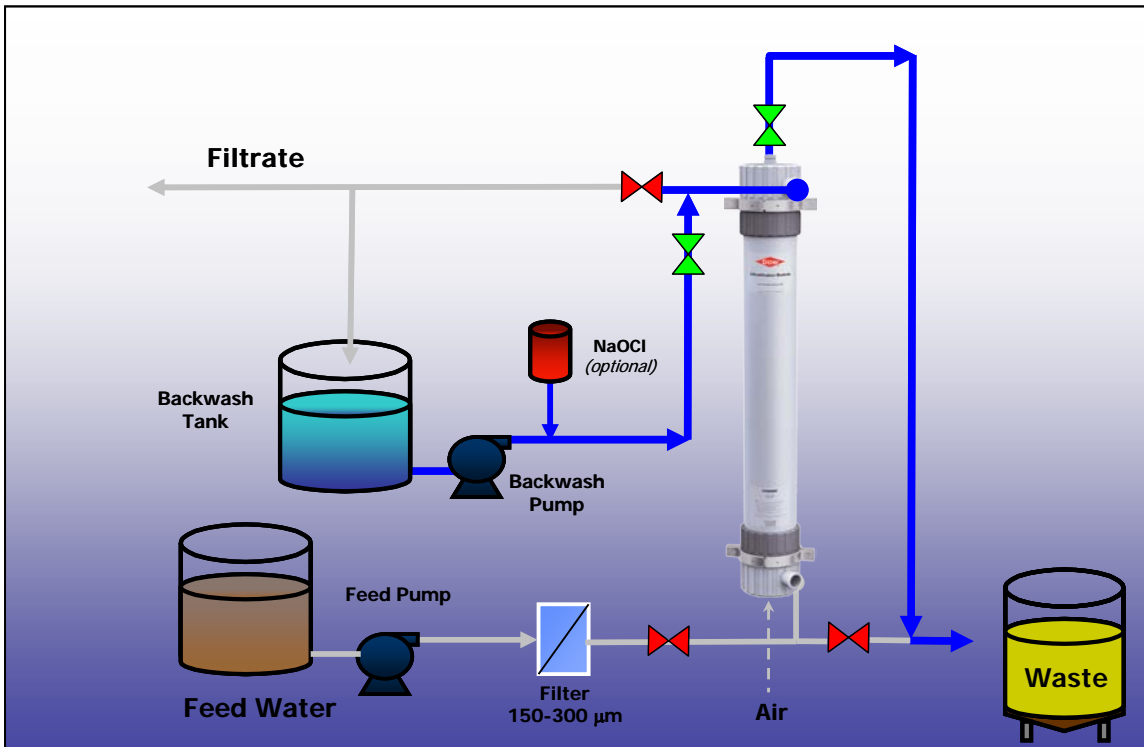

Figure 14: Top Backwash Step for DOW UF Modules

The *second backwash* step is performed to remove contaminants through the bottom of the module housing. Filtrate flow is reversed from the inside of the fiber to the outside and backwash flow is removed from the module housing through the bottom drain on the module for efficient removal of heavier materials. The two steps of backwash can be repeated numerous times depending on the degree of fouling. After backwash is complete, a *forward flush* is performed to remove any remaining contaminants and remove any air trapped on the outside of the fibers. After a backwash, the modules are returned to the *operating* mode.

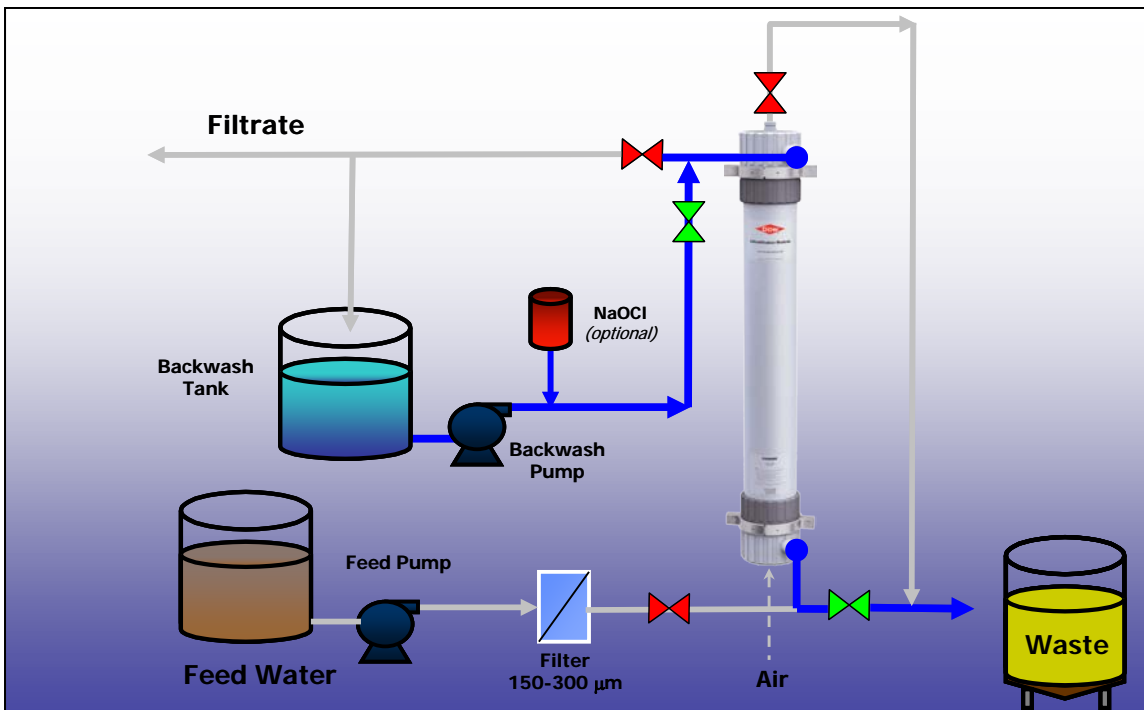

Figure 15: Bottom Backwash Step for DOW UF Modules

If the modules are taken out of service, the following steps should be taken: perform a backwash sequence, dose a chemical preservative to the modules, and close all valves on the modules.

CEB operation refers to a chemically enhanced backwash. The frequency of a CEB is dependant on the feed water quality. On high quality feed waters a CEB may not be required. The CEB process occurs automatically but the frequency can be adjusted after gaining operating experience. The CEB is performed using UF filtrate and either an acid or base combined with an oxidant is added to more effectively clean contaminants from the membrane surface. The choice of chemicals added is made according the DOW Ultrafiltration projection software (UFlow) used in the design of the system.

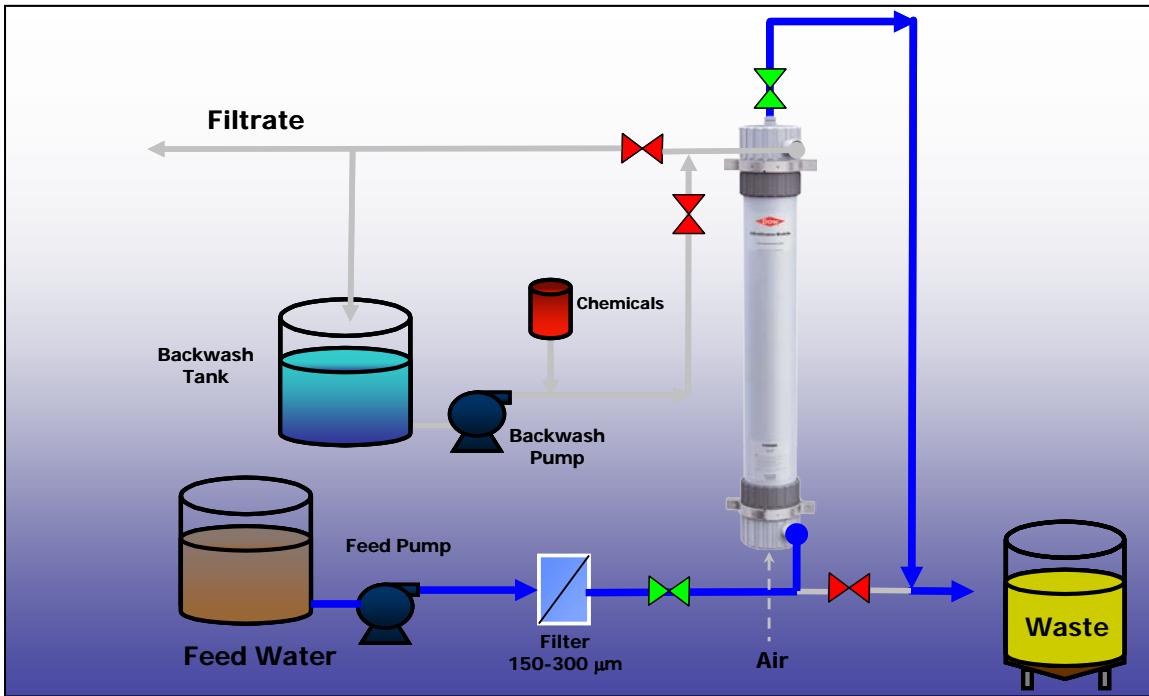

Figure 16: Forward Flush Step for DOW UF Modules

The CEB follows the steps of a normal *backwash* except a CEB chemical is dosed into the backwash water and a soak step is added after the second backwash step.

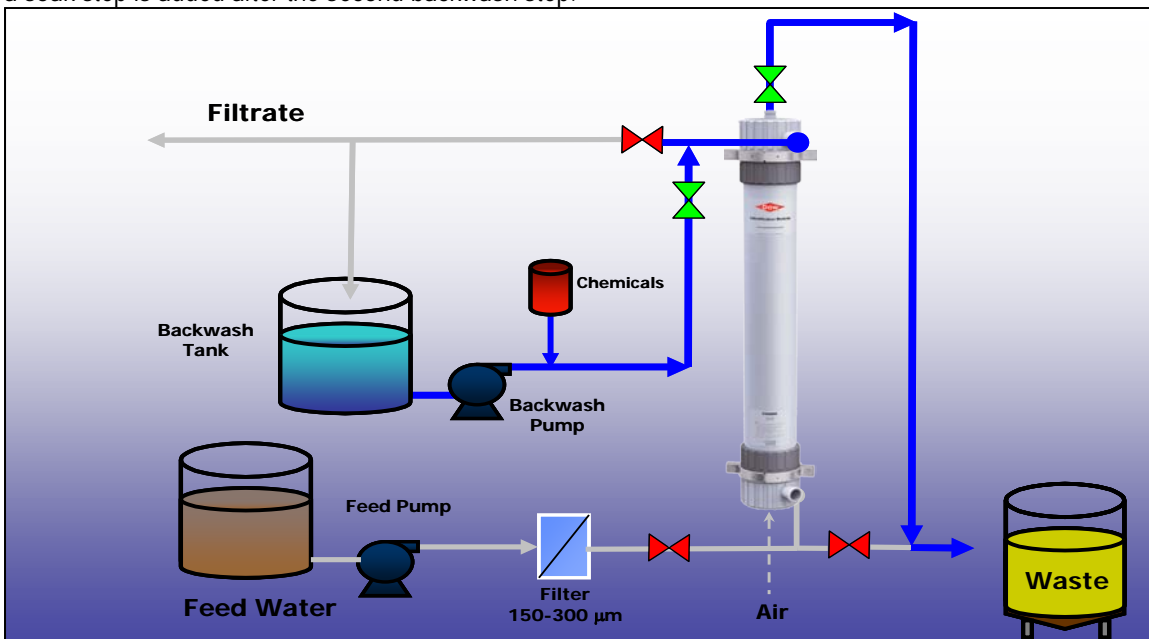

Figure 17: Chemically Enhanced Backwash "Top" Step for DOW UF Modules

The **soak** is performed for 5 to 20 minutes and allows more time for the chemical to react with contaminants that have attached to the membrane surface or penetrated the fiber wall. Intermittent air scour can be applied during the soak step. After the soak a routine backwash including air scour, top and bottom backwash, and forward flush is performed to remove any remaining particulates and residual chemicals. After a CEB and at the start of the **operating** step, filtrate may be wasted to remove residual chemicals.

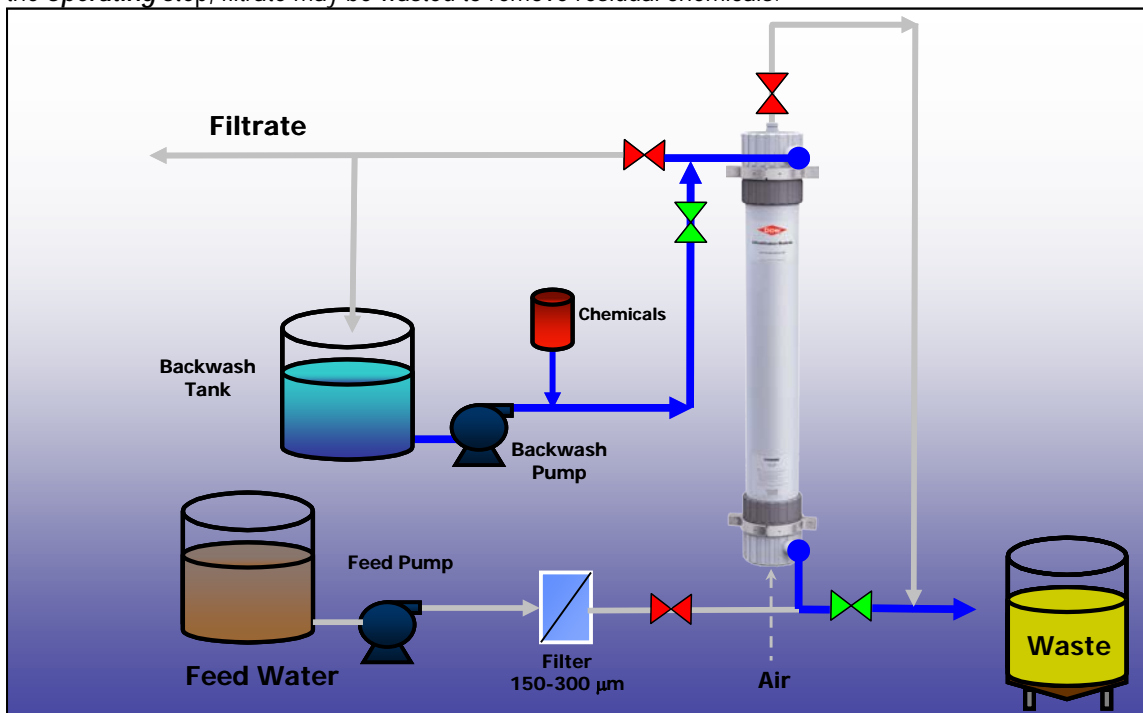

Figure 18: Chemically Enhanced Backwash “Bottom” step for DOW UF Modules

## CIP

A clean in place (**CIP**) operation includes backwash and chemical recycle to clean the fibers. The CIP is a on demand operation. The frequency of a CIP is dependant on the feed water quality but can range from 1 to 3 months. Prior to a CIP the routine **backwash** steps including air scour, draining, backwash through the top drain, and backwash through the bottom drain are performed. The backwash steps are repeated 3 to 8 times to remove contaminants or foulants not requiring chemical removal. After completing the backwash steps, the module is **drained** by gravity to remove excess water and prevent dilution of the CIP chemicals. CIP chemicals are **recycled** on the outside of the module for 30 minutes through the chemical cleaning tank. A small chemical filtrate stream will also be collected and recycled to the chemical cleaning tank. Note that the CIP solution can be heated up to 40°C to improve its effectiveness at removing contaminants from the membrane. A **soak** follows the initial recycle step for 60 minutes or longer depending on the degree of fouling that has occurred. After the soak step, CIP chemicals are again **recycled** on the outside of the module for 30 minutes. When the recycle is completed an air scour is performed and then the module is **drained** to remove concentrated chemicals. The 2 steps of **backwash** and a **forward flush** are performed to remove any remaining contaminants on the outside of the fibers. After a CIP and at the start of the **operating** step, filtrate may be used to remove residual chemicals held in the fiber or module. The CIP steps described above are for a single alkali or acid chemical solution. If an acid and alkali cleaning are required, the CIP steps would be repeated for each chemical solution.

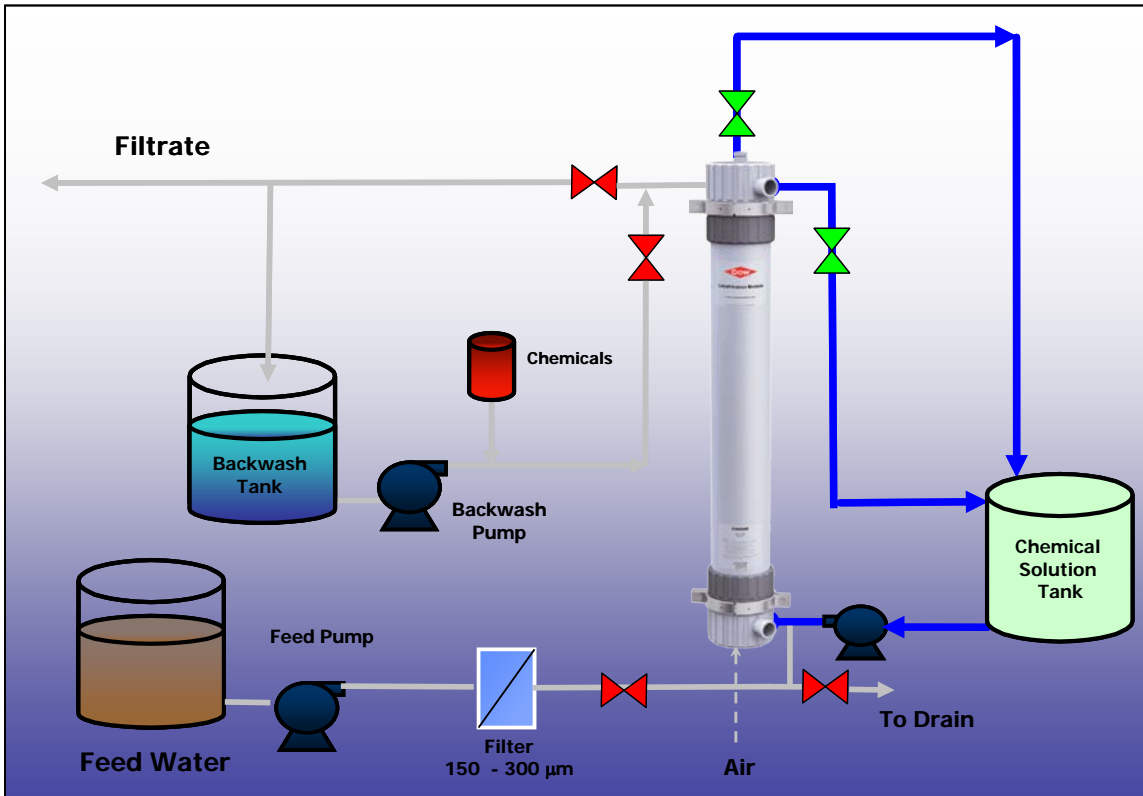

Figure 19: Clean In Place Cleaning Step for DOW UF Modules

#### 4.2 PRETREATMENT

DOW Ultrafiltration modules designs are based on qualified feed water conditions as shown in Table 6. The UF modules can tolerate period excursions in feed water quality as shown as the maximum allowable. If the feed water quality is outside of the design basis range shown below a pilot study should be operated to confirm performance or pretreatment must be considered. If the system is designed and installed to the conditions below but the feed water quality is not maintained *Dow Water & Process Solutions* should be consulted.

Table 6: Qualified Feed Water Quality Parameters

Parameter	Unit	Design Basis	Maximum Allowable
Turbidity	NTU	<50	300
TOC	mg/l	<10	40
Particle Size	micron	<150	300
COD <sub>Mn</sub>	mg/l	<20	60
Oil /Grease	mg/l	0	< 2
pH continuous		6-9	2-11
Temperature	°C	25	40
Cl <sub>2</sub> continuous	mg/l	0.5	200
TSS	mg/l	50	100

Depending on application, a safety screen of 150 – 300 microns is recommended on the feed to the UF system. A variety of technologies can be used such as self-cleaning screens and bag, cartridge, or disc filters. Depending on the type of water or range of feed water parameters other pretreatment technologies such as oxidation, coagulation, sedimentation and media filtration may also be recommended.

## 4.3 CLEANING

### SUMMARY OF INFORMATION

The process operating parameters for the cleaning steps are provided in Table 7 below.

**Table 7: Summary of Cleaning Processes**

Backwash Frequency		Once every 20 to 60 minutes ( water source or pilot test results)
Backwash Duration		40 to 120 seconds
Backwash Flux		100 to 150 l/m <sup>2</sup> ·h (60 - 90 gfd)
Air Scour	Maximum Inlet Pressure	2.5 bar (36 psi)
	Air Flow per Module	5 to 12 Nm <sup>3</sup> /h (3 - 7 scfm)
	Duration	20 to 60 seconds per cycle
	Air-Water Mix Entrance Pressure	≤ 1.0 bar (14 psi)
	Air Quality	Non-oil compressed air
Chemically Enhanced Backwash	Frequency	As needed
	Duration	Backwash Time plus soak 5 to 20 minutes
	Cleaning Solutions	0.1 % HCl, 2% Citric, 2% Oxalic 0.1% NaOCl, 0.05% NaOH
Clean In Place	Frequency	When TMP exceeds 1.0 bar above starting TMP (at same temperature)
	Duration	120 minutes (recycle and soak) or longer
	Cleaning Solutions	0.2% HCl, 2% Citric, 2% Oxalic 0.1%NaOH +0.2% NaOCl
	Cleaning Flux per Module	1.0 – 1.5 m <sup>3</sup> /h (6.6 - 8.8 gpm)
	Temperature Range	10 to 40 °C (34 - 104 °)

## 4.4 FOULING

There are four types of fouling common to UF operations including particulate, biological, inorganic, and organic.

Particulate fouling is caused by suspended solids, colloids, and turbidity that can be reduced by coagulation, sedimentation, clarification, and media filtration. The common cleaning method for particulate fouling is air scour and backwash.

Biological fouling is caused by the growth of microorganisms that can be reduced by using in-line chemical feed of chlorine or biocide or by elimination of nutrients by using PAC, GAC, or coagulation. The common cleaning method for removal of biological fouling is Chemically Enhanced Backwash (CEB) with oxidizers or biocides (Cl<sub>2</sub>, H<sub>2</sub>O<sub>2</sub>, SBS).

Inorganic fouling is caused by the precipitation of inorganics on the membrane that can be reduced by using oxidation/precipitation and filtration as pretreatment to the UF or in some cases using low hardness water for the alkali chemically enhanced backwash. The common cleaning method for removal of inorganic fouling is chemically enhanced backwash with acid at pH 2 (HCl, H<sub>2</sub>SO<sub>4</sub>, Citric, Oxalic Acid).

Organic fouling is caused by organics adsorbing on the membrane (silt, organic acids, humus) that can be reduced by using PAC, GAC, or coagulation. The common cleaning method for removal of organic fouling is CEB with alkali at pH 12 (NaOH).

## 5. OPERATING INFORMATION

### 5.1 START UP

The following procedures should be followed for the start-up of DOW™ Ultrafiltration modules. Manually start the equipment during initial operation. Flush the UF parts to remove the preservative used in shipping or the storage solution before starting the equipment. Target a filtrate flow of 60% of design during initial operations. After 24 hours the filtrate flow can be adjusted to design conditions.

## PRE-START CHECKS

1. The UF pre-treatment system should operate properly and the UF feed water should meet the design requirements. Ensure that chemical addition points are properly located and that proper mixing of chemicals in the feed streams can occur. Check the addition of pretreatment chemicals.
2. Verify that the drain/waste collection system is functional
3. Verify that the PLC program is loaded and functioning
4. Complete an electrical system check. Verify that the instrumentation is working and calibration is completed. Calibrate gauges and meters based on manufacturers' recommendations.
5. Clean and connect interconnecting piping. Flush system without modules to remove fabrication debris. During the flushing operation, check all pipe connections and valves for leaks. Tighten connections where necessary.
6. Residual air should be removed from the system during start-up.

## START UP

Check that all valves are closed and pumps are off before starting the system. Start the equipment by following the steps below:

1. Pumps should be aligned, lubricated, and properly rotated.
2. Start the feed pump
3. Fill equipment and start a flush
4. Start the backwash pump
5. Set and adjust the backwash pressure
6. Set and adjust the inlet air pressure
7. Set backwash time interval
8. Set air scour time interval
9. Set backwash sequence

## MODULE FLUSHING

The DOW Ultrafiltration modules should be rinsed prior to startup to remove preservative fluid shipped in the modules. Flushing should be performed until no foam is observed in the wash water. Depending on the treatment application, additional rinsing or disposal of the filtrate may be required.

NSF / ANSI Standard 61 certified modules require the following conditioning rinse prior to producing potable water:

1. Rinse the modules at a feed rate of 40 LMH minimum for a period of 4 Hours.
2. Achieve a minimum total rinse volume of 160 LMH-Hours using the feed water available.
3. The concentrate bleed rate should be set from between 0% to 20% with the balance being filtrate.
4. During the rinse cycle, perform standard cleaning protocols as defined per the manufacturer's recommendations which are specifically designed to consider the feed water quality available.
5. The filtrate should be sent to the appropriate disposal system based on the regulations that apply to the location where the conditioning rinse is carried out and not used as potable water.
6. Local regulations may require additional conditioning of the system prior to producing potable water.

## 5.2 INTEGRITY TESTING PROCEDURES

Two methods are commonly used for integrity testing.

### BUBBLE TEST

Leaking modules can be found using a skid pressure hold test and a transparent bubble tube.

1. Take the module out of the filtration mode.
2. Drain the module from the feed side.
3. Close feed and concentrate valve and align filtrate valve to allow flow to drain through the transparent tube. Also isolate the bank of modules being tested from other operating banks of modules.
4. Pressurize the drained side of the module with oil-free compressed air from the air inlet valve, and slowly raise the air pressure to a maximum of 2 bars (29 psi). Some displaced water will flow out the filtrate side.

If large continuous air bubbles appear in the transparent tube then the module has broken fibers. Smaller and infrequent bubbles are the result of air diffusion through the pores of the ultrafiltration membrane.

#### PRESSURE HOLD/DECAY

1. Take the UF unit or module out of the filtration mode. Drain the water from the feed side of the module. Close the feed and concentrate valves (see Figure 21) and keep the filtrate valve open.
2. Pressurize the membrane module with oil free compressed air from the air inlet valve, and slowly raise the air pressure to a maximum of 2 bars (29 psi). Some displaced water will flow out through the filtrate side for up to two minutes.
3. Close the air inlet valve.
4. Hold the pressure for 10 minutes. The membrane is integral (no leaks) if the pressure drop is lower than 0.2 bar (2.9 psi). If the pressure drop is greater than 0.2 bar in 10 minutes (2.9 psi in 10 minutes) then membrane fibers are compromised and require repair.
5. Repair the membrane following the "fiber test and repair procedure".

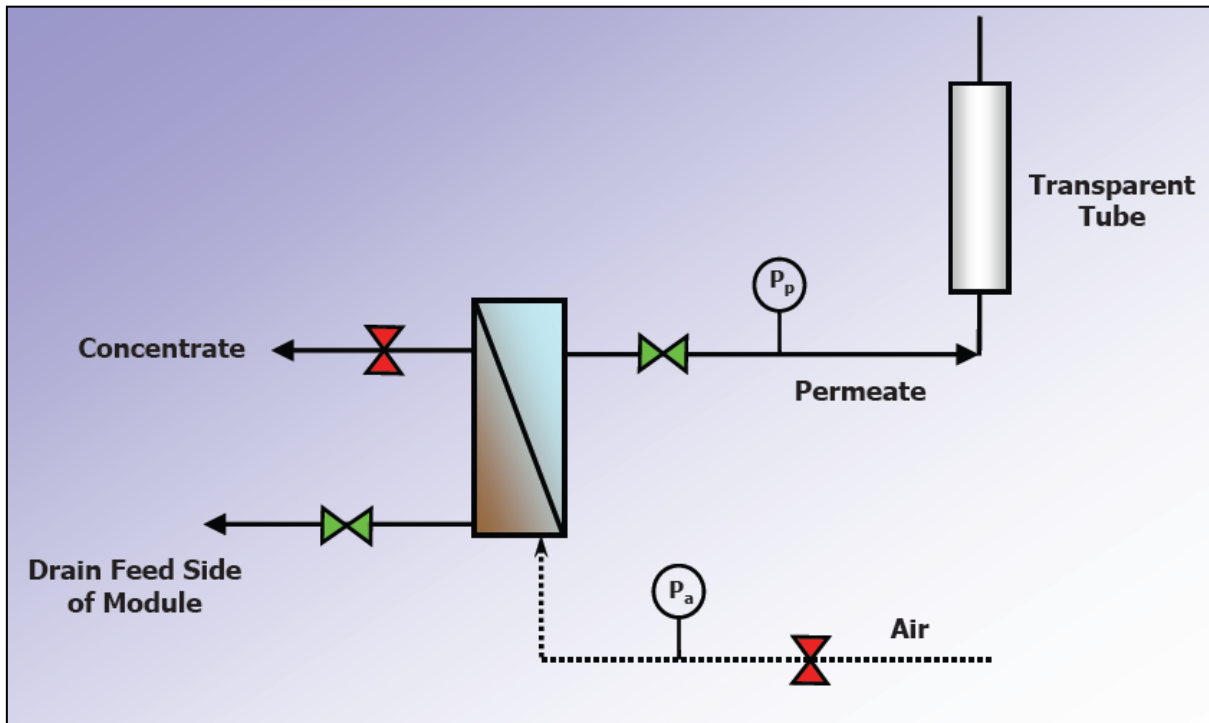

Figure 20: Pressure Hold Test Schematic

### 5.3 SHUT DOWN

#### MANUAL SHUT DOWN

To conduct a manual shut down open the concentrate rinse valve and flush for 15 seconds. Then slowly close the inlet valve.

#### EQUIPMENT SHUT DOWN DURING AUTOMATIC OPERATION

The equipment will automatically stop or will not allow automatic operation if the feed pump did not start when operation was initiated or the inlet or filtrate pressure is too high to operate.

#### LONG TERM EQUIPMENT SHUT DOWN

If the equipment is down for more than two days, operation for 30 to 60 minutes per day can protect the equipment from bacterial fouling. If the equipment is down for more than seven days apply a manual air scrub before turning off the equipment, add a storage solution (1%  $\text{NaHSO}_3$ ), and close all valves. During long term storage, pH should be checked monthly. Replace the storage solution if the pH is less than 3. During shut down, the UF membrane should always keep moist. The membrane components will be irreversibly damaged after drying.



#### 5.4 OPERATING AND CLEANING LOGS

Recording data is useful for tracking operating conditions and to optimize operations. The frequency of data collection will depend on the use of the filtrate water. Attached are two logs for use during operations. One is the Data Log Sheet for use during normal filtration and operations. The second is the CIP Record Sheet, which is used to collect information from the clean in place step.

## DOW™ Ultrafiltration Data Log Sheet

Customer:			
System Information: (pretreatment process, chemical feed type and dosages, etc):			
UF Module Type:	Number of Skids:	Number of Modules/skid:	Membrane Area:
Date:	Time:	Cumulative hours of operation:	Recorded By:
<b>Parameters</b>	<b>Unit</b>	<b>Recorded Value</b>	<b>Comments</b>
<b>Data Collected</b>			
Temperature (T)	°C or °F		
Pre-filter Inlet Pressure	Psi or bar		
Pre-filter Outlet Pressure	Psi or bar		
UF Feed Pressure (P <sub>f</sub> )	Psi or bar		
UF Filtrate Pressure (P <sub>p</sub> )	Psi or bar		
UF Concentrate Pressure (P <sub>c</sub> )	Psi or bar		
UF Filtrate Flow / skid (Q <sub>p</sub> )	gpm or m <sup>3</sup> /hr		
UF Backwash Flow / skid (Q <sub>bw</sub> )	gpm or m <sup>3</sup> /hr		
UF Forward Flush / skid (Q <sub>ff</sub> )	gpm or m <sup>3</sup> /hr		
Filtration time per cycle (t <sub>f</sub> )	minutes		
Backwash time per cycle (t <sub>bw</sub> )	seconds		
Forward flush time per cycle (t <sub>ff</sub> )	seconds		
Air Scour time per cycle	seconds		
CEB Alkali frequency	hours		
CEB Alkali pH	---		
CEB Acid frequency	hours		
CEB Acid pH	---		
UF Feed Turbidity	NTU		
UF Filtrate Turbidity	NTU		
UF Feed TSS	ppm or mg/L		
UF Filtrate TSS	ppm or mg/L		
UF Filtrate SDI <sub>15</sub>	---		
<b>Performance</b>			
Gross Flux (J)	Gfd or l/mh		
Transmembrane Pressure (TMP)	Psi or bar		
Permeability (L <sub>N,20</sub> )	Gfd/psi or l/mh/bar		
<b>Equations to Calculate Performance</b>			
Transmembrane Pressure (TMP) = P <sub>f</sub> - P <sub>p</sub>			
Recovery (R) = (Q <sub>p</sub> * t <sub>f</sub> - Q <sub>bw</sub> * t <sub>bw</sub> ) / (Q <sub>p</sub> * t <sub>f</sub> + Q <sub>ff</sub> * t <sub>ff</sub> ) * 100			

DOW™ Ultrafiltration CIP Record Sheet				
Customer:				
System Information: (pretreatment process, chemical feed type and dosages, etc)				
UF Module Type:	Number of Skids:	Number of Modules/skid:	Cumulative hours of operation:	Total number of cleaning:
Date:	Time:	Cumulative hours of operation after last cleaning:		Recorded By:
Item	Unit	First Solution	Second Solution	Remarks
<b>Pre-cleaning Air Scour and Backwash</b>				
Backwash Water Source	---			
Backwash Flux	LMH or gfd			
Air flow rate per module	Nm <sup>3</sup> /h or scfm			
<b>Cleaning Chemicals</b>				
Volume of cleaning solution	Liters or gallon			
Acid (also list type used)	Liters or gallon			
Caustic soda ( %)	Liters or gallon			
Sodium hypochlorite ( %)	Liters or gallon			
Others Chemicals	Liters or gallon			
<b>CIP Operating Conditions</b>				
Solution concentration	%			
pH	---			
Temperature	°C or °F			
Circulation flow rate	m <sup>3</sup> /h or gpm			
Duration of initial circulation	Minutes			
Soaking period	Minutes			
Duration of final circulation	Minutes			
<b>Final Backwash or Flush/Rinse</b>				
Source of water	---			
Flow rate	m <sup>3</sup> /h or gpm			
Duration	Minutes			
pH of waste streams	---			

## Dow Water & Process Solutions Offices.

For more information call Dow Water & Process Solutions:

### Europe

Dow Customer Information Group  
Dow Water & Process Solutions

Prins Boudewijnlaan 41

B-2650 Edegem

Belgium

Tel. +32 3 450 2240

Tel. +800 3 694 6367 †

Fax +32 3 450 2815

Contact the Customer Information Group

### Japan

Dow Chemical Japan Ltd.

Dow Water & Process Solutions

Tennoz Central Tower

2-24 Higashi Shinagawa 2-chome

Shinagawa-ku, Tokyo 140-8617

Japan

Tel. +81 3 5460 2100

Fax +81 3 5460 6246

Contact the Customer Information Group

### Peoples Republic of China

Dow Chemical (China) Investment Company Ltd.

Dow Water & Process Solutions

No.936,Zhangheng Rd,

Zhangjiang Hi-Tech Park

Shanghai 201203

China

Tel. +86 21 3851 1000

Fax +86 21 5895 1818

Contact the Customer Information Group

### Asia Pacific

Customer Information Group – Dow Water & Process  
Solutions

All countries except Indonesia and Vietnam:

Toll free phone: +800 7776 7776

Toll free fax: +800 7779 7779

All countries:

Tel. +60 3 7958 3392

Fax +60 3 7958 5598

Contact the Customer Information Group

### Latin America

Dow Quimica S.A.

Dow Water & Process Solutions

Rua Alexandre Dumas, 1671

Sao Paulo – SP – Brazil

CEP 04717-903

Tel. 55-11-5188 9222

Fax 55-11-5188 9919

Contact the Customer Information Group

### North America

The Dow Chemical Company  
Dow Water & Process Solutions

Customer Information Group

P.O. Box 1206

Midland, MI 48641-1206

USA

Tel. 1-800-447-4369

Fax (989) 832-1465

Contact the Customer Information Group

### Internet

<http://www.dowwaterandprocess.com>

† Toll-free telephone number for the following countries: Austria, Belgium, Denmark, Finland, France, Germany, Hungary, Ireland, Italy, The Netherlands, Norway, Portugal, Spain, Sweden, Switzerland, and the United Kingdom

**NOTICE:** No freedom from any patent owned by Dow or others is to be inferred. Because use conditions and applicable laws may differ from one location to another and may change with time, Customer is responsible for determining whether products and the information in this document are appropriate for Customer's use and for ensuring that Customer's workplace and disposal practices are in compliance with applicable laws and other government enactments. The product shown in this literature may not be available for sale and/or available in all geographies where Dow is represented. The claims made may not have been approved for use in all countries. Dow assumes no obligation or liability for the information in this document. References to "Dow" or the "Company" mean the Dow legal entity selling the products to Customer unless otherwise expressly noted. **NO WARRANTIES ARE GIVEN; ALL IMPLIED WARRANTIES OF MERCHANTABILITY OR FITNESS FOR A PARTICULAR PURPOSE ARE EXPRESSLY EXCLUDED.**



®Trademark of The Dow Chemical Company  
("Dow") or an affiliated company of Dow